

INSTRUCTION MANUAL

PC1080 SK-100124

SKYRC

PRODUCT DESCRIPTION

Thank you for choosing SkyRC PC1080 dual channel LiPo charger.

This charger is capable of balance charging 2 packs of 6 cell batteries simultaneously. It is specifically designed for big battery pack. There are three working modes, fast charge, balance charge and storage.

Master and Slave mode are available, enabling the user to perform synchronous settings for numerous (synchronize 2 or more) chargers via data cables. In addition, PC1080 has short-circuit, reverse polarity, and overheat protection to ensure maximum safety.

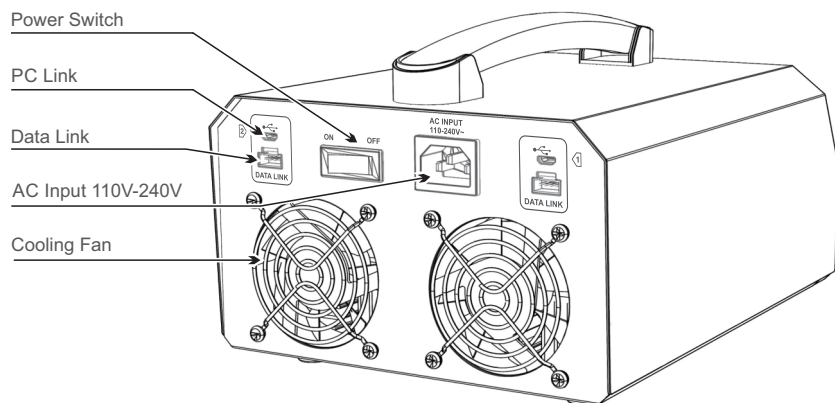
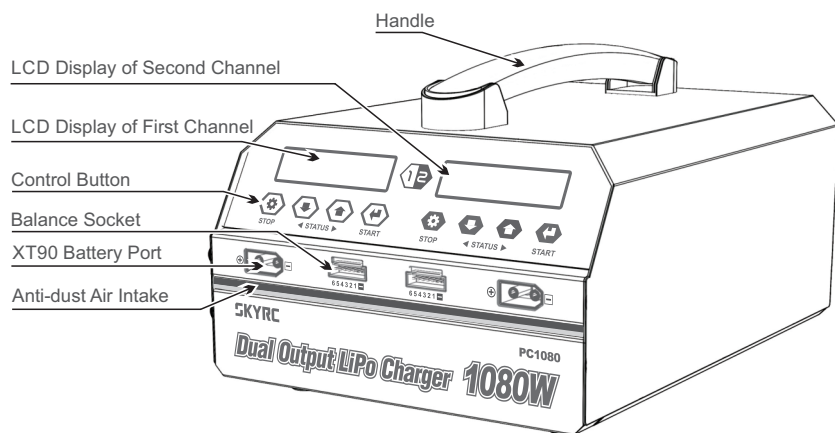

FEATURES

- Support charging 2 packs of 6s LiPo batteries simultaneously
- Support high voltage LiPo (LiHV) battery
- Memorizing last charging current
- Three working modes: fast charge, balance charge & storage
- Master & Slave mode available
- Synchronize 2 or more chargers via data cable.
- Maximum safety: short circuit protection, reverse polarity protection & over heat protection.
- Adjustable charging current
- 2x16 LCD screen.
- Real time charging/ discharging status display
- Battery voltage meter
- Battery internal resistance meter
- Firmware upgrade via USB port

PACKAGE CONTENTS

- ① SkyRC PC1080 charger
- ② AC power cord
- ③ Synchronous data connectors

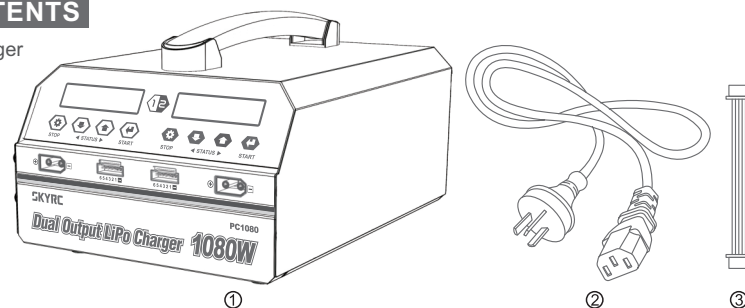

OPERATION PROCEDURE

- 1) Power on: connect to the power source and turn on the power switch. A beep sound will be heard, and the LCD screen will be displayed as below:



- 2) Battery connection: Please connect your batteries to PC1080 charger as below:
(Note: Be aware that the Lithium battery to be charged should be 6 cells. Make sure the battery balance lead and charging lead are connected correspondingly to the charger.)

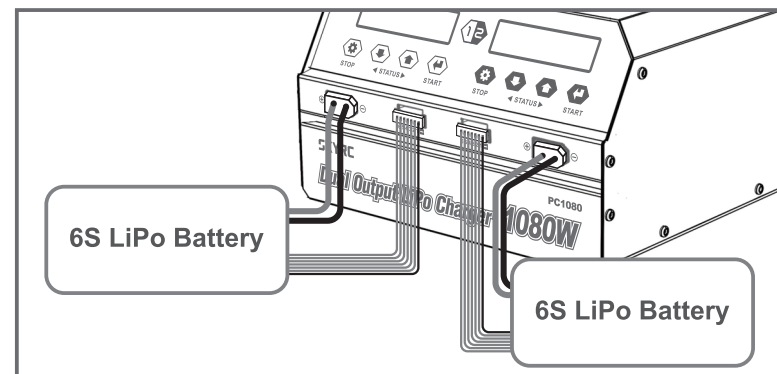

3) Parameters settings



LiPo FAST CHARGE
2.0A OFF-LINE

Press , the working mode will be blinking



LiPo FAST CHARGE
2.0A OFF-LINE

Press  or  to select FAST CHARGE, BALANCE CHG or STORAGE

LiPo FAST CHARGE
2.0A OFF-LINE

Press  again, the current option will start blinking; Press  or  to set the charging current with the range of 1.0A - 20.0A.

LiPo FAST CHARGE
10.0A OFF-LINE

Press  again to choose synchronous mode. Press  or  to set "MASTER" or "SLAVE".

LiPo FAST CHARGE
10.0A MASTER

1 2

LiPo FAST CHARGE
10.0A SLAVE

Either of the channels is MASTER, the other will automatically change to 'SLAVE'. All the settings must be done through "MASTER".

LiPo FAST CHARGE
10.0A MASTER

Press and hold  for 2 seconds to start charging.

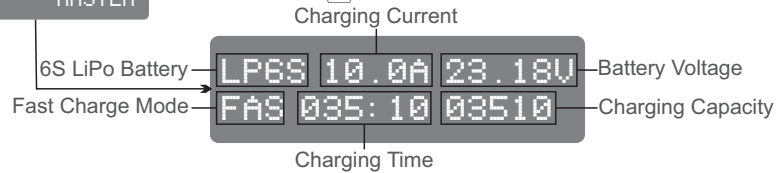

4) Stop: if you'd like to terminate charging during the charging process, press . Under Master-Slave mode, any operation must be carried out on the Master channel.

5) Finish: In charging mode, when the charging process comes to an end, the screen will be displayed as below.

[END: FINISH]
25.20V 3500mAh

SYNCHRONIZATION

PC1080 charger can be synchronized via data cables. Below illustrates how to charge 8 batteries of the same type.

Make sure all the chargers set to "OFF-LINE" first. If a certain channel is selected as "MASTER" channel, then the other channels will be "SLAVE." The settings on "MASTER" can be applied to all the chargers, which saves your time significantly.

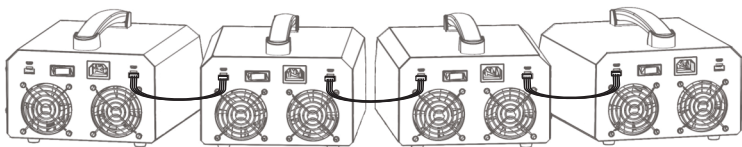



STORAGE

If a Lithium battery is not used for long time, it's highly recommended to charge or discharge the battery to 3.9V with STORAGE mode so as to extend the battery life. If the battery voltage is higher than 3.9V, the charger will discharge the battery; If battery voltage less than 3.9V per cell, the charger will charge the battery under STORAGE mode.

LiPo FAST CHARGE
2.0A OFF-LINE



Press  the charging mode will blink.

LiPo STORAGE
2.0A OFF-LINE

Press  or  to select STORAGE mode.

SWITCH BETWEEN LIPO AND LIHV

! This function must be used with caution, as charging incorrect type of battery will damage the battery, or even cause fire or explosion.

Press and hold  and  at the same time for 5 seconds until the corresponding battery type appears on the screen.

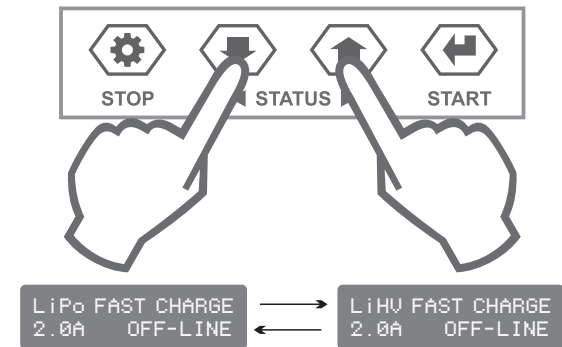

BATTERY VOLTAGE METER

Press  a few times until the screen displays the battery meter. This function can detect the remaining capacity, battery voltage per cell, total voltage, highest voltage & lowest voltage.

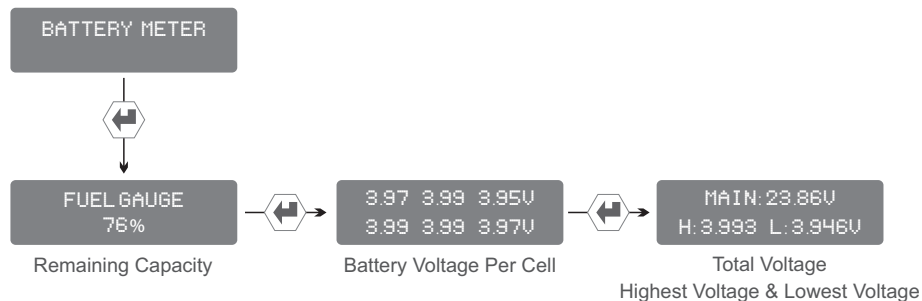

BATTERY RESISTANCE METER

Press  a few times until the screen displays the battery resistance meter. This function can detect internal resistance per cell and total resistance. The lower the battery resistance is, the higher the battery performance will be. Internal resistance will increase after the battery is commonly used.



SYSTEM SETUP

Press  several times until the screen displays the system setup.

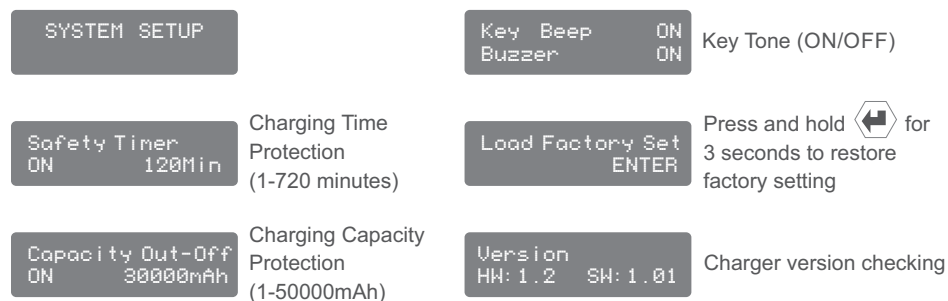

ERRORS

NO BATT DETECTED	Failure to detect the battery	OVER TIME LIMIT	Charging time exceeds the setting time
CELL ERROR	Incorrect cell count	INT. TEMP TOO HI	High internal temperature
CONNECT ERROR CHECK MAIN PORT	Connection error & Check Main Port	REVERSE POLARITY	Reverse Polarity
OVER CHARGE CAPACITY LIMIT	Over capacity protection	BATTERY WAS FULL	Battery fully charged
CONTROL FAIL	Control failure	CELLS VOLTAGE HI CHECK MAIN PORT	Cells Voltage Hi Check Main Port

SPECIFICATIONS

- Input Voltage: 110-240V
- Output Power: 1080W (540W×2)
- Discharging Power: 50W×2
- Charging Current Range: 1.0-20.0A×2
- Balance Current: 1.2A Max.
- Battery Type: LiPo/LiHV
- Battery Cell Count: 6s×2
- Charging Modes: Fast Charge/Balance Charge/Storage
- Working Environment: Temperature: 0°C/32°F ~ 40°C/104°F
Humidity: 5% ~ 75%
- Storage Environment: Temperature: -10°C/14°F ~ 70°C/158°F
Humidity: 5% ~ 75%
- Size: 272×202×118.6mm
- Weight: 4.88kg

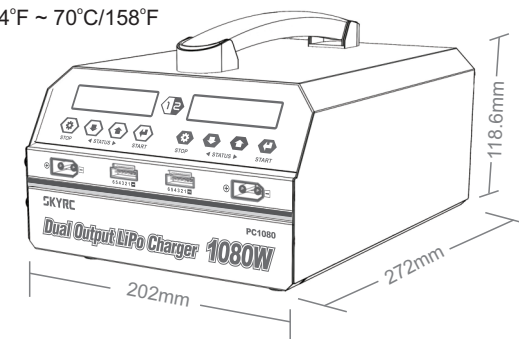

WARNING AND SAFETY PRECAUTIONS

These warnings and safety notes are particularly important. Please follow the instructions for maximum safety. Otherwise the charger and the battery can be damaged or at worst it can catch fire.

- ❗ Never leave the charger unattended when it is connected to its power supply. If any malfunction is found, TERMINATE THE PROCESS AT ONCE and refer to the operation manual.
- ❗ Keep the charger well away from dust, moist, rain, heat, direct sunshine and vibration.
- ❗ Never drop it.
- ❗ The allowable AC input voltage is AC 110-240V.
- ❗ This charger and the battery should be put on a heat-resistant, non-inflammable and non-conductive surface. Never place them on a car seat, carpet or the like. Keep all the inflammable and volatile materials away from the operating area.
- ❗ Make sure you know the specifications of the battery to be charged or discharged to ensure it meets the requirements of this charger. If the program is set up incorrectly, the battery and charger may be damaged. It can cause fire or explosion due to overcharging.

❗ Never attempt to charge or discharge the following types of batteries

A battery pack which consists of different types of cells (including different manufacturers)

A battery already fully charged or just slightly discharged

Non-rechargeable batteries (Explosion hazard)

A battery requires a different charge technique

A faulty or damaged battery

A battery fitted with an integral charge circuit or a protection circuit.

Batteries installed in other devices or connected to other parts.

Batteries that are not expressly stated by the manufacturer to be suitable for the currents the charger delivers during the charge process.

❗ Please bear in mind the following points before beginning charging:

Did you select the appropriate program suitable for the type of battery you are charging?

Did you set up adequate current for charging?

Have you checked that all connections are firm and secure?

Make sure there are no intermittent contacts at any point in the circuit.

❗ Charging

During the charge process, a specific quantity of electrical energy is fed into the battery. The charge capacity is calculated by multiplying charge current by charge time. The maximum permissible charge current varies depending on the battery type or its performance, and can be found in the information provided by the battery manufacturer. Only batteries that are expressly stated to be capable of quick-charge are allowed to be charged at rates higher than the standard charge current.

Connect the battery to the terminal of the charger. Red is positive and black is negative. Due to the difference between resistance of cable and connector, the charger cannot detect resistance of the battery pack. The essential requirement for the charger to work properly is that the charge lead should be of adequate conductor cross-section and that high quality connectors which are normally gold-plated should be fitted to both ends.

Always refer to the manual by the battery manufacturer about charging methods, recommended charging current and charging time. Especially, the lithium battery should be charged strictly according to the charging instruction provided by the manufacturer.

Special attention should be paid to the connection of lithium battery.

Do not attempt to disassemble the battery pack arbitrarily.

Be aware that lithium battery packs can be wired in parallel or in series. When the battery is connected in parallel, its capacity is calculated by multiplying the single battery capacity by the number of cells with the total voltage staying the same. Voltage imbalance may cause fire or explosion. Lithium battery is recommended for charging in series.

- ❗ The charger is not suitable for children under 14 years old. People with behavior disturbance, mental disorder or no experience should use it under the supervision and guidance. Children are forbidden to play with it. They are also NOT allowed to clean and maintain the device without the supervision.
- ❗ If the power cord is damaged, please return it back to the factory, supplier or technicians for replacement for fear of danger.

Liability exclusion

This charger is designed and approved exclusively for use with the types of battery stated in this Instruction Manual. SkyRC accepts no liability of any kind if the charger is used for any purpose other than that stated.

We are unable to ensure that you follow the instructions supplied with the charger, and we have no control over the methods you employ for using, operating and maintaining the device. For this reason we are obliged to deny all liability for loss, damage or costs which are incurred due to the incompetent or incorrect use and operation of our products, or which are connected with such operation in any way. Unless otherwise prescribed by law, our obligation to pay compensation, regardless of the legal argument employed, is limited to the invoice value of those SkyRC products which were immediately and directly involved in the event in which the damage occurred.

Warranty and service

We guarantee this product to be free of manufacturing and assembly defects for a period of one year from the time of purchase. The warranty only applies to material or operational defects, which are present at the time of purchase. During that period, we will repair or replace free of service charge for products deemed defective due to those causes.

This warranty is not valid for any damage or subsequent damage arising as a result of misuse, modification or as a result of failure to observe the procedures outlined in this manual.

Note:

1. The warranty service is valid in China only.
2. If you need warranty service overseas, please contact your dealer in the first instance, who is responsible for processing guarantee claims overseas. Due to high shipping cost, complicated custom clearance procedures to send back to China. Please understand SkyRC can't provide warranty service to overseas end user directly.
3. If you have any questions which are not mentioned in the manual, please feel free to send email to info@skycrc.com

The manual is subject to change without notice; please refer to our website for the latest version!



Manufactured by
SKYRC TECHNOLOGY CO., LTD.
www.skycrc.com

Floors 4, 5, & 8, Building 4, Meitai Technology Park,
Guangang South Road, Guanlan, Longhua District,
Shenzhen 518110, China

7504-0882-08